

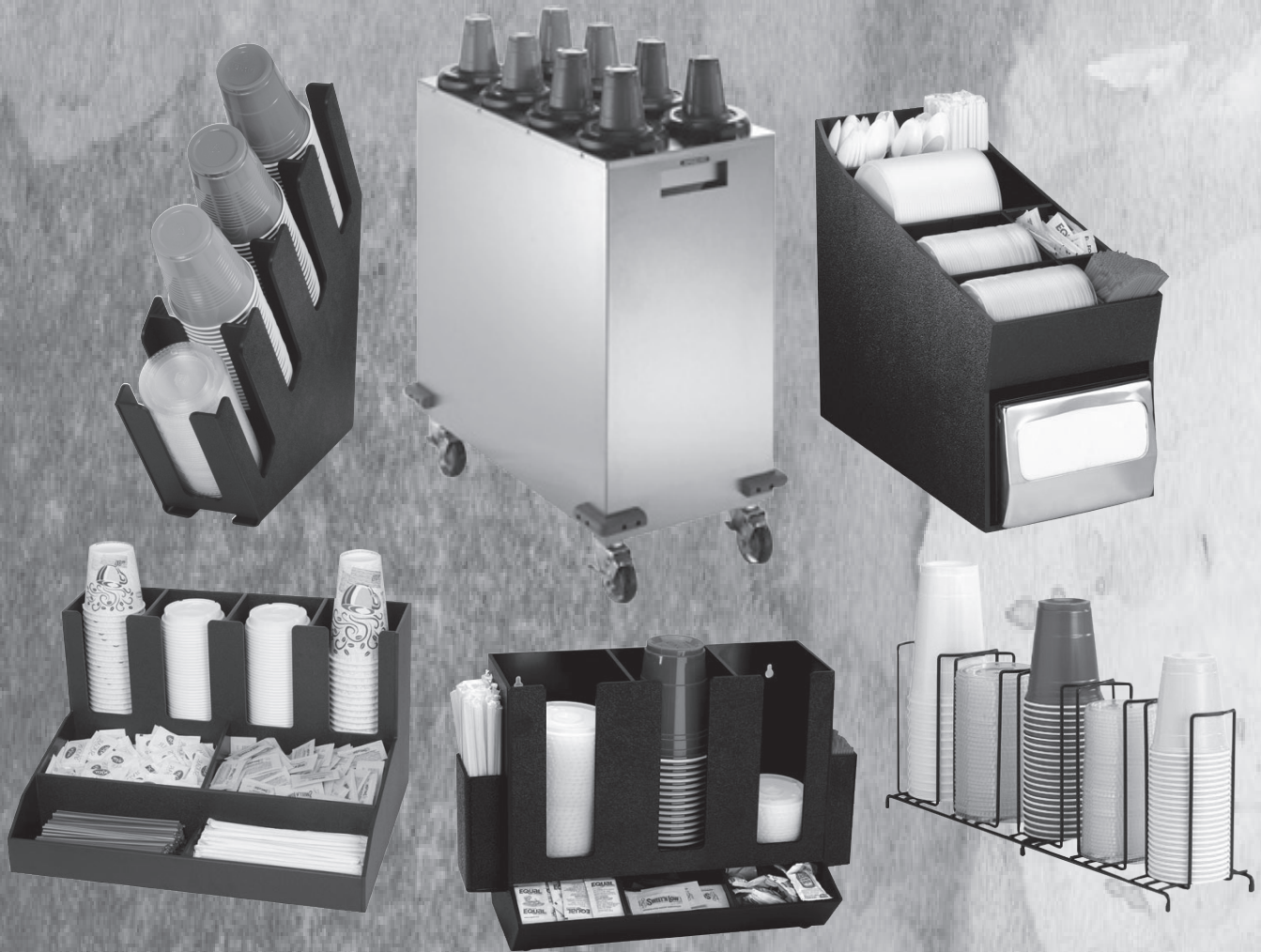

Gorman Supply, Inc.

Cup Dispensing Catalog 2024



All products



Made in USA

www.gormansupply.com



Visa & MasterCard Accepted
No Minimums Required

PULL TYPE / ADJUSTABLE

MODEL NUMBER	CUP BRIM DIAMETER	LENGTH	QUANTITY PER CASE	PRICE / QTY ORDERED	
				1 to 11	12 to 47
G13020	6-12 OZ. CUPS 2 ¹ / ₄ " to 2 ⁷ / ₈ "	25 ³ / ₄ "	12	54.00	49.70
G13030	12-22 OZ. CUPS 2 ⁷ / ₈ " to 3 ¹ / ₂ "	25 ³ / ₄ "	12	61.00	56.55
G13050	32 OZ. CUPS 3 ¹ / ₂ " to 4 ¹ / ₈ "	25 ⁷ / ₈ "	12	65.00	60.00
G13060	44 OZ. CUPS 4 ¹ / ₈ " to 4 ⁷ / ₈ "	26 ⁷ / ₈ "	12	78.00	73.00

Stainless Steel features: Easy dial adjustment • Each unit comes with 2 springs (1 standard spring for paper and plastic cups, 1 lighter spring for foam cups) • Stainless steel grips ensure one-at-a-time dispensing, Mounts horizontally or vertically



ELEVATOR / SPRING LOADED / ADJUSTABLE

MODEL NUMBER	CUP BRIM DIAMETER	LENGTH	QUANTITY PER CASE	PRICE / QTY ORDERED	
				1 to 11	12 to 47
G13120	6-12 OZ. CUPS 2 ¹ / ₄ " to 2 ⁷ / ₈ "	25 ³ / ₄ "	12	96.00	89.40
G13130	12-22 OZ. CUPS 2 ⁷ / ₈ " to 3 ¹ / ₂ "	25 ³ / ₄ "	12	98.25	92.00
G13150	32 OZ. CUPS 3 ¹ / ₂ " to 4 ¹ / ₈ "	25 ⁷ / ₈ "	12	102.65	95.30
G13160	44 OZ. CUPS 4 ¹ / ₈ " to 4 ⁷ / ₈ "	26 ⁷ / ₈ "	12	105.50	98.00

Stainless Steel features: Easy dial adjustment • Each unit comes with 2 springs (1 standard spring for paper and plastic cups, 1 lighter spring for foam cups) • Stainless steel grips ensure one-at-a-time dispensing, Mounts horizontally or vertically





IN-COUNTER ADJUSTABLE CUP DISPENSERS

STAINLESS STEEL

MODEL NUMBER	CUP BRIM DIAMETER	LENGTH	QUANTITY PER CASE	PRICE / QTY ORDERED	
				1	12
G13220	4-12 OZ. CUPS 2½" to 3½"	22"	12	108.00	100.45
G13250	8-44 OZ. CUPS 3" to 4⅝"	22"	6	1	6
				119.00	110.50
G13260	44-64 OZ. CUPS 4½" to 5¼"	22"	6	153.00	142.00

Stainless Steel features: Easy dial adjustment • Each unit comes with 2 springs (1 standard spring for paper and plastic cups, 1 lighter spring for foam cups) • Stainless steel grips ensure one-at-a-time dispensing, Mounts horizontally or vertically

IN-COUNTER ADJUSTABLE CUP DISPENSERS

ABS PLASTIC

MODEL NUMBER	CUP BRIM DIAMETER	DIMENSIONS	QUANTITY PER CASE	PRICE / QTY ORDERED	
				1	6
G13340	8-44 OZ. CUPS 2¼" to 4¾"	24⅜" L x 6½" W	6	153.00	142.20

Plastic features: Molded silicone gasket for easy cup release • Easy attachable collar • Durable construction • 4 different-sized gaskets come with each unit to accommodate paper, plastic or foam cups • Mounts horizontally or vertically

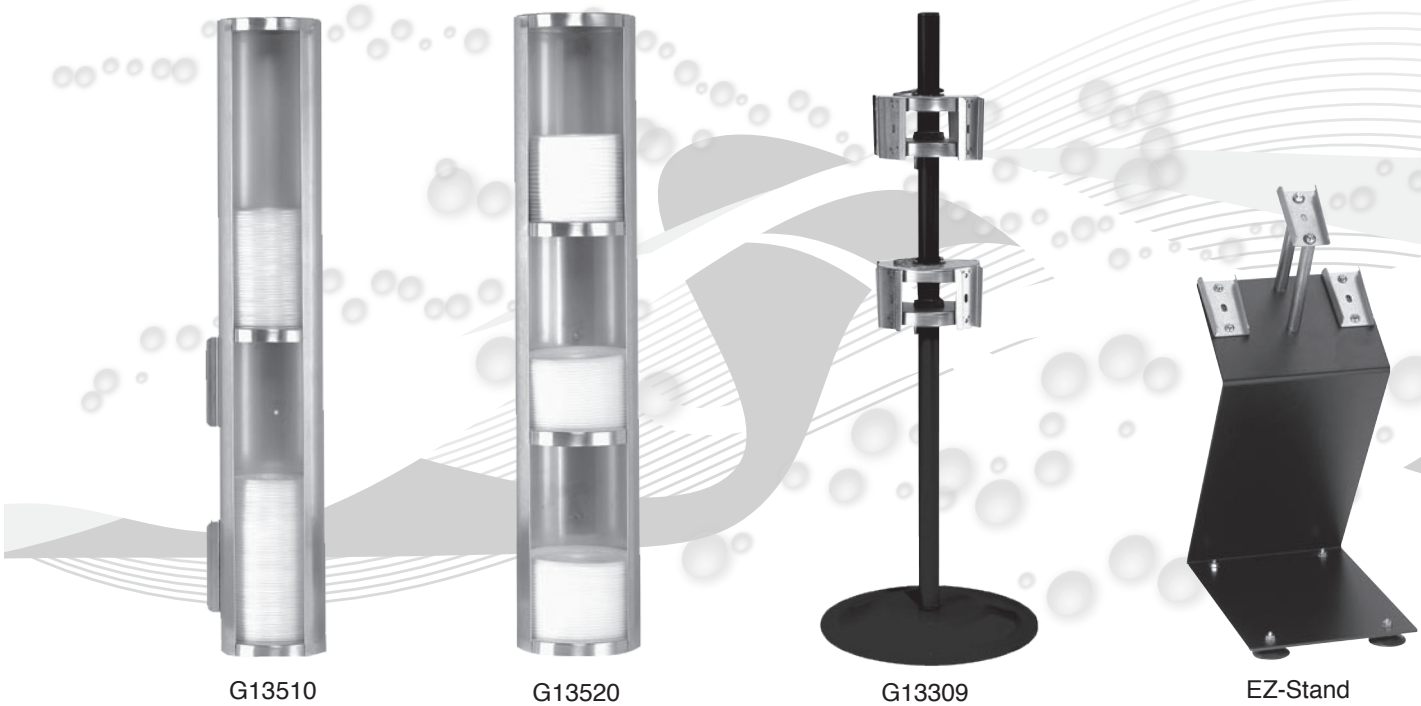

LID DISPENSERS

WILL DISPENSE PAPER, FOAM OR PLASTIC

MODEL NUMBER	SHELVES	MAX LID DIAMETER	LENGTH	QUANTITY PER CASE	PRICE / QTY ORDERED	
					1 to 11	12 to 47
G13510	2	4 ¹ / ₈ " 6 - 24 OZ. CUPS	25 ¹ / ₂ "	12	81.55	76.00
G13520	3	4 ³ / ₄ " 12-44 OZ. CUPS	25 ¹ / ₂ "	12	95.40	88.60

ROTATING STAND

CHROME PLATED

MODEL NUMBER	CAPACITY	DIMENSIONS	QTY/ CASE	PRICE / QTY ORDERED
				1 to 99
G13309	Standing model holds any 4 dispenser combinations	40" H x 15" W x 15" D	1	261.00

Dispensers sold separately

With quick-release mounting brackets.

EZ-STAND

CHROME PLATED

MODEL NUMBER	CAPACITY	DIMENSIONS	QTY/ CASE	PRICE / QTY ORDERED
				1 to 99
EZ-Stand	Standing model holds any 3 dispenser combinations	29" H x 15" W x 15" D	1	114.00

Dispensers sold separately



G13503-A



G13504-A



G13505-A

COUNTER TOP LID, STRAW, CONDIMENT COMBINATION

MODEL NUMBER	DIMENSIONS	NUMBER OF SECTIONS	QUANTITY PER CASE	PRICE / QTY ORDERED
				1 to 99
G13503-A	8" H x 12½" W x 5" D	3 with straw holder	1	187.70
G13504-A	8" H x 16½" W x 5" D	4 with straw holder	1	206.15
G13505-A	8" H x 22½" W x 5" D	5 with straw holder	1	223.00



G13926



G12055



G13927

ONE SIZE FITS ALL CUP DISPENSER CABINETS

MODEL NUMBER	DESCRIPTION	DIMENSIONS H x W x D (inches)	QTY/ CASE	COST/ UNIT
G13926	3-Lid sections and 2 straw/stirrer bins	24¼ x 6½ x 14	1	215.00
G13927	3 section dome lid and straw organizer	24¼ x 6½ x 14	1	240.00

ICE CREAM CONE STAND

MODEL NUMBER	DESCRIPTION	DIMENSIONS H x W x D (inches)	QTY/ CASE	COST/ UNIT
G12055	Boxed cone dispenser stand	15½ x 9 x 11¼	1	154.00



G13930



G13940

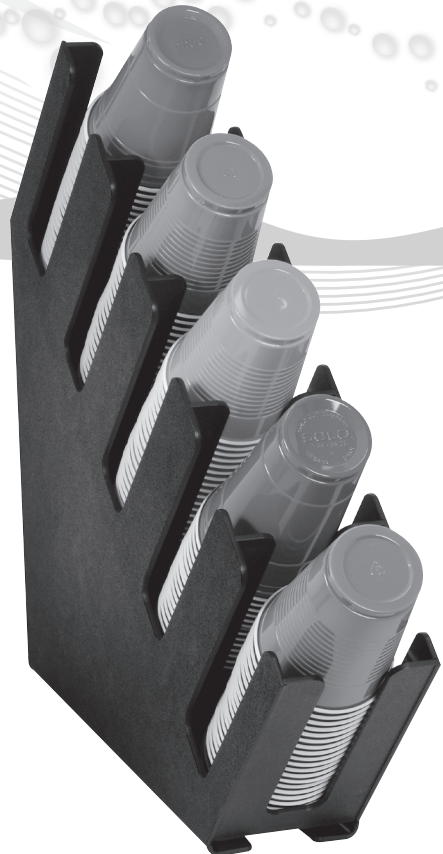

G13950



G13960

COUNTERTOP CUP & LID ORGANIZERS

MODEL NUMBER	CUP SIZE	DESCRIPTION	DIMENSIONS	QTY/ CASE	COST/ UNIT
G13930	6-44 OZ.	3-section lid & cup organizer 2 ³ / ₈ " x 4 ³ / ₄ " brim diameter	16 ¹ / ₂ "H x 5 ¹ / ₄ "W x 17"D	1	103.10
G13940	6-44 OZ.	4-section lid & cup organizer 2 ³ / ₈ " x 4 ³ / ₄ " brim diameter	19 ¹ / ₂ "H x 5 ¹ / ₄ "W x 20 ³ / ₄ "D	1	120.00
G13950	6-44 OZ.	5-section lid & cup organizer 2 ³ / ₈ " x 4 ³ / ₄ " brim diameter	23"H x 5 ¹ / ₄ "W x 24 ¹ / ₂ "D	1	136.00
G13960	N/A	This optional acrylic straw and condiment holder can be inserted into any section on the countertop organizers listed above to hold straws, stir sticks or packeted condiments.	6"H x 4"W x 4"D	1	40.00

Prices are subject to change without notice.

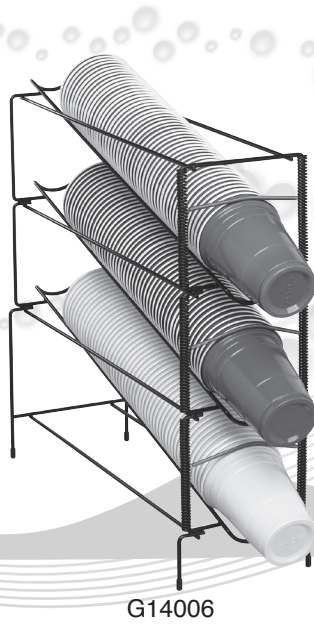

G14006

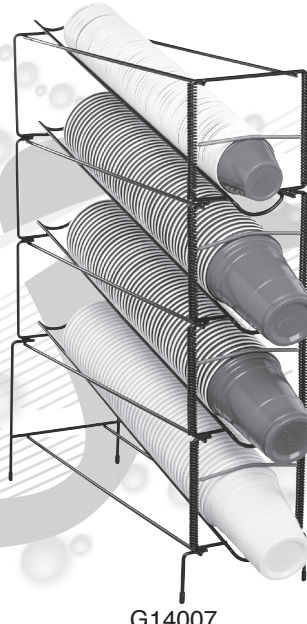

G14007



G14008



G14003



G14004



G14005

COUNTERTOP CUP & LID ORGANIZERS

MODEL NUMBER	CUP SIZE	DESCRIPTION	DIMENSIONS	QTY/ CASE	COST/ UNIT
G14003*	6-44 OZ.	3 sections (1) 3 1/2"; (1) 4 1/4"; (1) 4 3/4" wire rack	8 1/2"H x 14 1/2"W x 5"D	1	49.25
G14004*	6-44 OZ.	4 sections (4) 4 1/8" wire rack	8 1/2"H x 18 1/2"W x 5"D	1	50.80
G14005*	6-44 OZ.	5 sections (1) 3 1/2"; (2) 4 1/4"; (2) 5" wire rack	8 1/2"H x 23"W x 5"D	1	52.30
G14006	6-44 OZ.	3-section vertical dispensing rack	19 1/4"H x 6 1/4"W x 20"D	1	111.00
G14007	6-44 OZ.	4-section vertical dispensing rack	24 3/4"H x 6 1/4"W x 20"D	1	119.00
G14008	6-44 OZ.	5-section vertical dispensing rack	29 1/4"H x 6 1/4"W x 20"D	1	140.00

***Requires a minimum order of 2 units.**

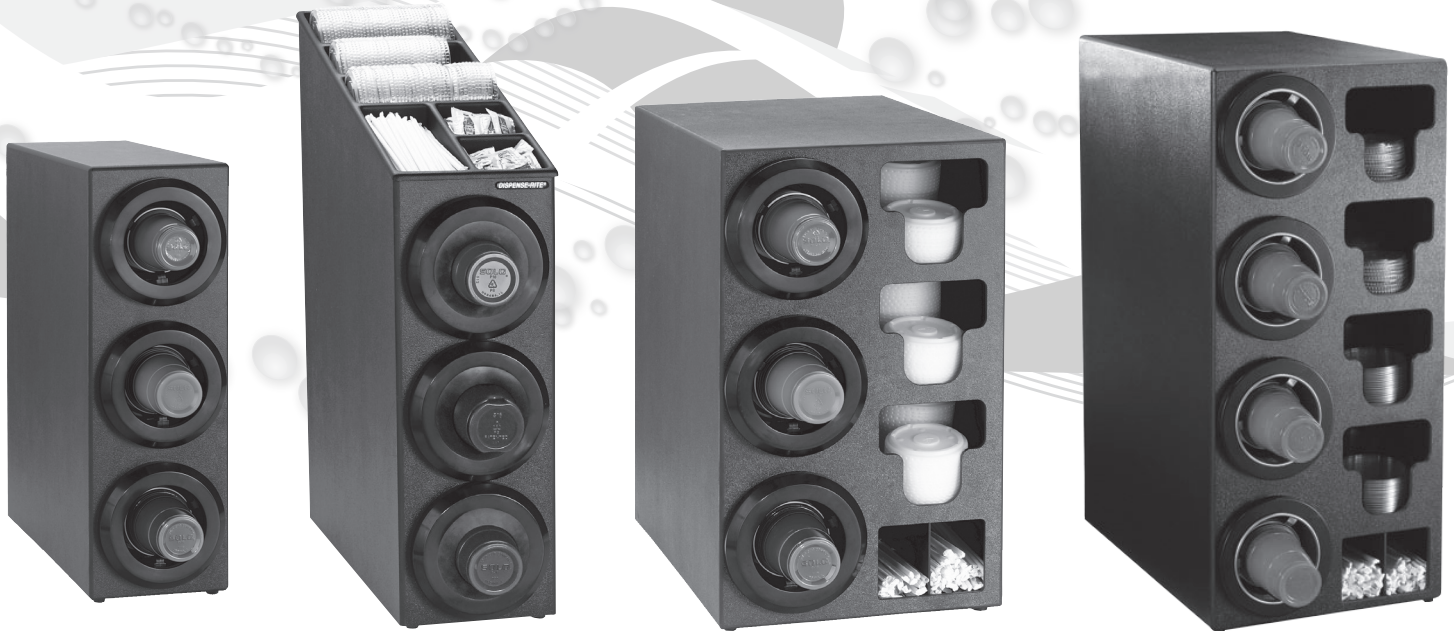

G13903

G13914

G13917

G13918

ONE SIZE FITS ALL CUP, LID AND STRAW CABINET

MODEL NUMBER	CUP SIZE	DESCRIPTION	DIMENSIONS	QTY/ CASE	COST/ UNIT
G13903	8-44 OZ.	3-cup vertical dispenser 3 ¹ / ₈ " to 4 ¹ / ₂ " brim diameter	24 ¹ / ₂ "H x 8"W x 23"D	1	388.00
G13914	8-44 OZ.	3-cup vertical dispenser with storage in top 3 ¹ / ₈ " to 4 ¹ / ₂ " brim diameter	29 ¹ / ₄ "H x 8 ¹ / ₂ "W x 24"D	1	497.00
G13917	8-44 OZ.	3-cup vertical dispenser with lid and straw storage 3" to 4 ¹ / ₂ " brim diameter	23 ³ / ₄ "H x 13 ³ / ₄ "W x 23 ³ / ₈ "D	1	556.00
G13918	8-44 OZ.	4-cup vertical dispenser with 4 lids and straw storage	31 ¹ / ₄ "H x 13 ³ / ₄ "W x 23 ³ / ₈ "D	1	873.00

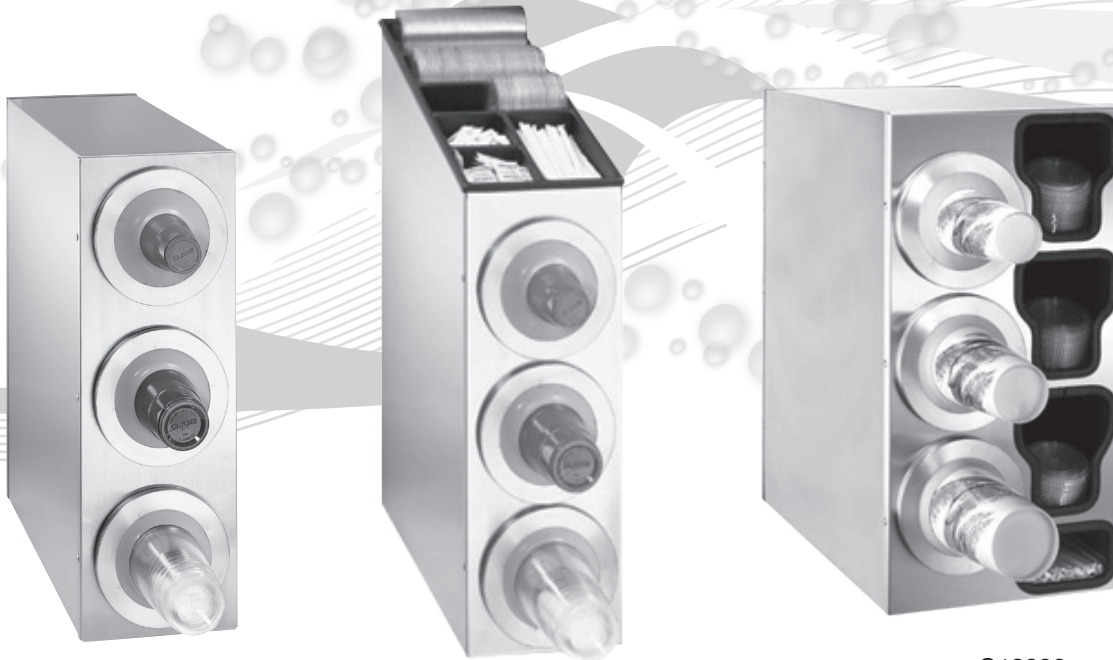

G13865

G13876

G13886

ONE SIZE FITS ALL CUP DISPENSER CABINETS WITH BAFFLES

MODEL NUMBER	CUP SIZE	DESCRIPTION	DIMENSIONS	QTY/ CASE	COST/UNIT
G13865	8-44 OZ.	3-cup vertical dispenser 3" to 4 1/2" brim diameter	24 1/2"H x 8 1/8"W x 23"D	1	695.00
G13876	8-44 OZ.	3-cup vertical dispenser with storage in top 3" to 4 1/2" brim diameter	29 3/8"H x 8 3/8"W x 23 1/2"D	1	775.00
G13886	8-44 OZ.	3-cup vertical dispenser with lid and straw storage 3" to 4 1/2" brim diameter	24 1/2"H x 8 1/8"W x 23"D	1	1,128.00

FEATURES:

- One size fits all
- 8 oz. to 44 oz. cup sizes
- Interchangeable baffle system
- Integrated lid, straw and condiment organizer
- Paper, plastic or foam cups
- Quick release brackets



Mobile-4x1



Mobile-8



Mobile-2x2

MOBILE CUP DISPENSER CABINETS

MODEL NUMBER	NUMBER OF CUP DISPENSERS	CUP SIZE	CUP BRIM DIAMETER	DIMENSIONS	COST/UNIT
Mobile-4x1	4	8-44 oz.	3" x 4 1/2"	35"H x 12"W x 33"D	1,600.00
Mobile-8	8	8-44 oz.	3" x 4 1/2"	35"H x 17 1/2"W x 33"D	1,993.00
Mobile-2x2	4	8-44 oz.	3" x 4 1/2"	35"H x 17"W x 17"D	1,600.00

FEATURES:

- One size fits all
- 8 oz. to 44 oz. cup sizes
- Interchangeable baffle system
- Paper, plastic or foam cups
- Plastic tumblers
- Locking swivel casters
- Removeable bumper guards
- Built-in recessed handles
- 28" L high capacity dispensers
- NSF listed cup dispensers

TO PLACE AN ORDER:

For your convenience, our sales office hours are Monday - Friday from 8:30 AM - 5:30 PM EST. Please call using our **Toll-Free Line: (800) 543-2746** to speak with a sales representative.

You may also place an order, any time of the day or week, by **e-mailing us: gor874@fuse.net** or by using our **24 Hour Fax Line: (513) 874-8785**.

CREDIT TERMS:

15 Days net.

LEAD TIME:

Allow 3 weeks for production. 24 to 48 hour lead-time required on stock items.

TAX REQUIREMENTS:

Limited to OH only, we require a state Sales Tax Exemption Certificate.

RETURNED CHECKS:

Customers with returned checks due to insufficient funds will be charged a \$25.00 service fee.

WARRANTY:

30 DAYS replacement or credit to account with the exception of custom made-to-order products.

RETURNS:

- Return authorization must be given.
- Invoice number from order must be available.
- Merchandise must be received in saleable condition to receive credit.
- Return must be received within two weeks of notification.
- A 25% restocking fee applies to all merchandise unless a similar replacement is ordered.

We offer additional products including cash bags, safes for trucks, gauge cages, ad caps, aprons, inks & signs, and fiberglass tubs.



GORMAN SUPPLY, INC.
PO Box 1126
West Chester, Ohio 45071-1126

www.gormansupply.com

(800) 543-2746

FAX: (513) 874-8785